



COMFORT BARS for HONDA GL1800 2018 ~

P4014-003 Stainless Steel with Electropolish Finish
P4015-002 Steel with E-Coat and Black Powder Finish
Installation Video Available at nationalcycle.com

Thank you for purchasing a National Cycle product. Read these instructions carefully and thoroughly before beginning work. Dealers, if installing this wind-screen for a customer, please give them this manual upon completion. It contains information needed to properly maintain and use this product.

Please check the contents of this Kit with the Parts List and the Parts Diagram A on Page 3. Report any discrepancies to National Cycle, Inc. Please include the date on the outside of the package, and your place of purchase. Thank you.

 <p>Attention: Special notes and cautionary measures which can prevent damage to the accessory or motorcycle.</p>	 <p>Note: Tips for facilitation of operation, control and adjustment, as well as maintenance work.</p>
---	--

CONTENTS OF KIT Parts Diagram A, Page 3

ITEM	ELECTROPOLISH P4014-003	BLACK P4015-002	DESCRIPTION	QTY.	TOOLS / NOTES
1	90-970114-000	90-970116-000	Bar, Left Side	1	
2	90-970115-000	90-970117-000	Bar, Right Side	1	
	BAG#1308	BAG#1309			
3	50-505342-000	50-505342-000	Screw, SS M8 x 4 0	2	13mm Socket and Ratchet
4	49-491503-000	49-491503-000	Washer, Split	2	
5	37-374369-000	37-374398-000	Backing Plate	2	
6	51-515753-000	51-515753-000	Screw, SS, Front M8 x 50	2	6mm Hex Wrench
7	51-515748-000	51-515748-000	Screw, SS, Rear M8 x 45	2	6mm Hex Wrench
8	80-816008-000	80-816008-000	Sleeve	1	
9	42-423030-000	42-423030-000	Nut, M8-1.25	4	13mm Box Wrench
10	37-400550-000	37-400550-000	P Clamp, SS	2	
11	51-516215-000	51-516215-000	Screw, M5 x 16	2	3mm Hex Wrench
12	49-490317-000	49-490317-000	Washer, M8 SS	6	
13	49-490511-000	49-490511-000	Washer, SS M6	2	
14	42-423049-000	42-423049-000	Nut, M5	2	8mm Box Wrench
15	44-448861-000	44-448864-000	Plug	2	Decorative Plug

Additional Tools

- 5mm Hex Wrench
- 12mm Socket, Ratchet and Long Extension
- Tape
- Needle Nose Pliers

Tools to alter Black Cover (Optional)

- Dremel® Tool with .75" Cutting Wheel, Sharp Small Knife or Blade, Pencil and Ruler

For Use In

- Removal of Covers
- Removal of Stock Lower Bolt
- Protect Covers from Scratches
- Hold "P" Clamp During Installation

National Cycle, Inc. PO Box 158 Maywood, IL 60153-0158 USA
 708-343-0400 / Fax: 708-343-0625 / www.nationalcycle.com / info@nationalcycle.com

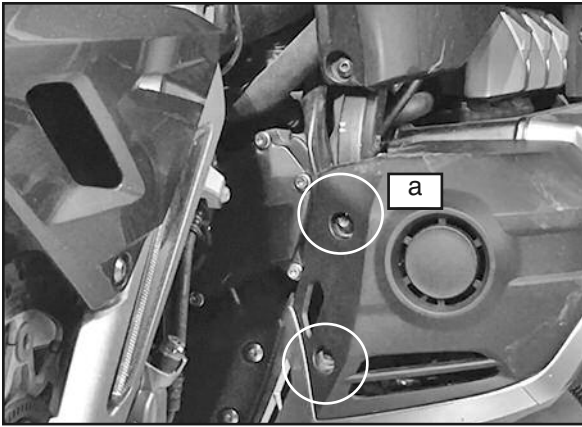

Figure 1

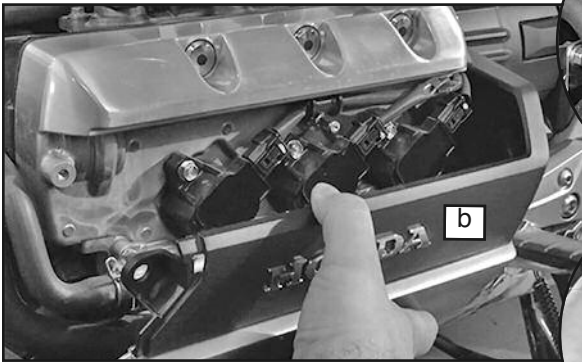

Figure 2

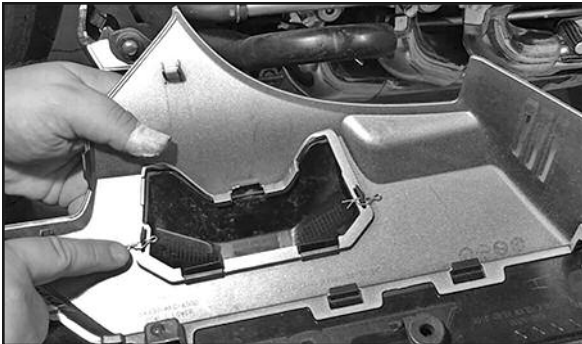

Figure 3

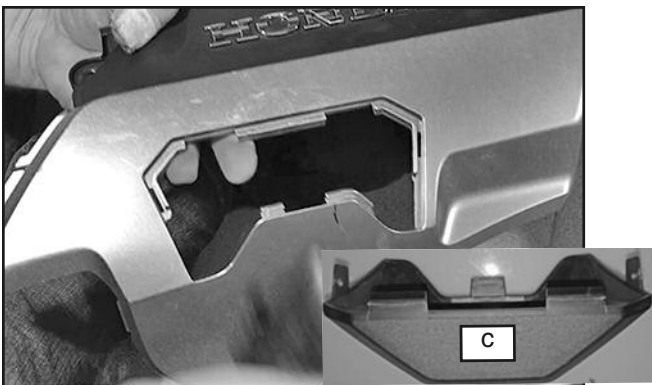

Figure 4

PREPARATION

1. Position motorcycle securely on its center stand or lift.

Working on LEFT side of motorcycle.

2. Remove Covers

Two front screws holding Axillary Light Cover (a). **(5mm Hex Wrench) Figure 1**

Two screws, front and rear, holding Decorative Valve Cover (b). **(5mm Hex Wrench) Figure 2**

3. Remove pins from inside of Valve Cover. **Figure 3**

4. Remove Black Cover (c). **Figure 4**

PARTS DIAGRAM A

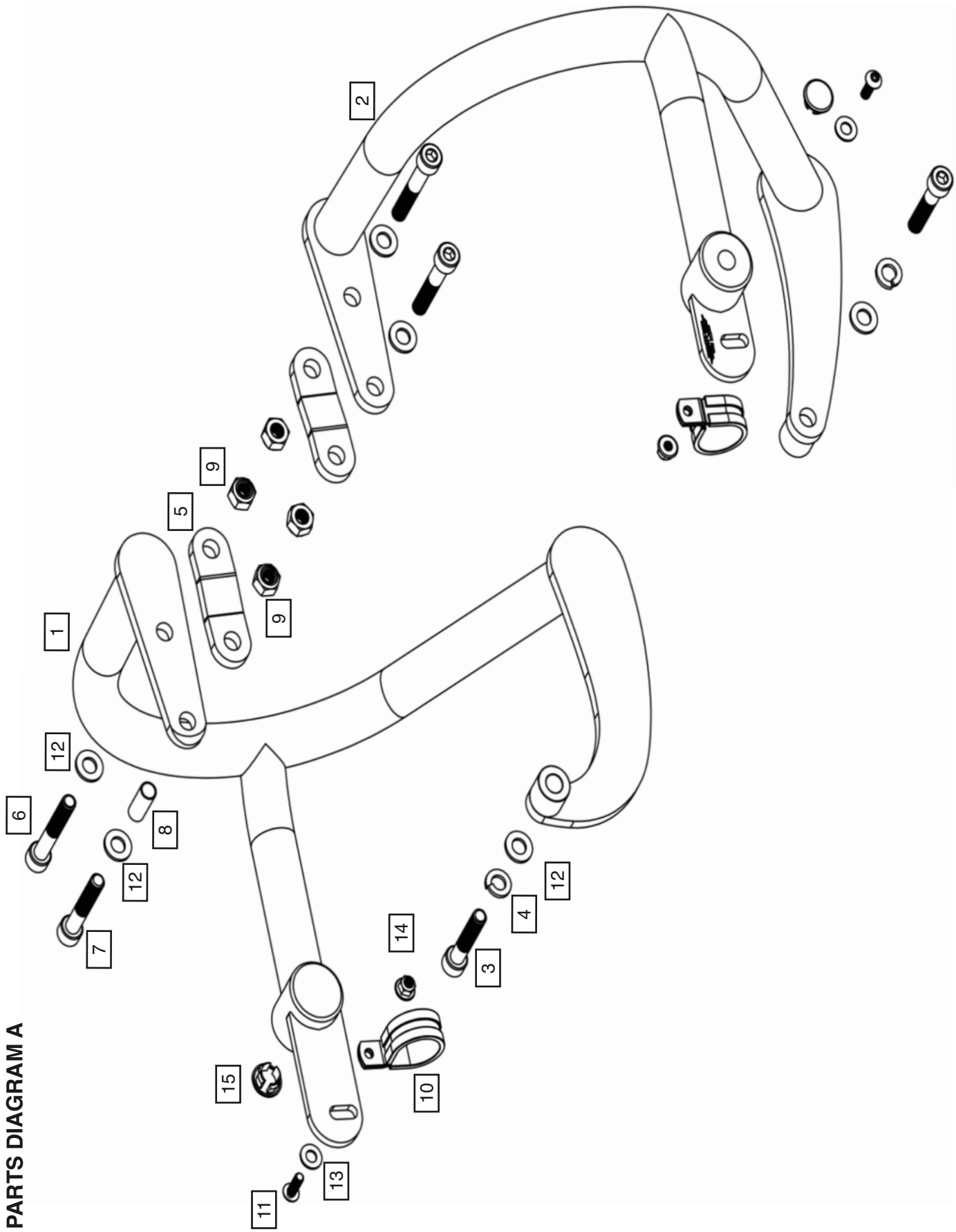

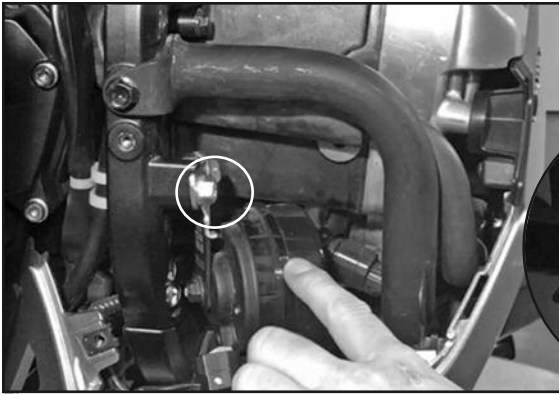

Figure 5



5. Remove the horn. Remove stock screw to temporarily remove the horn. **(12mm Box Wrench or Socket. Figure 5**

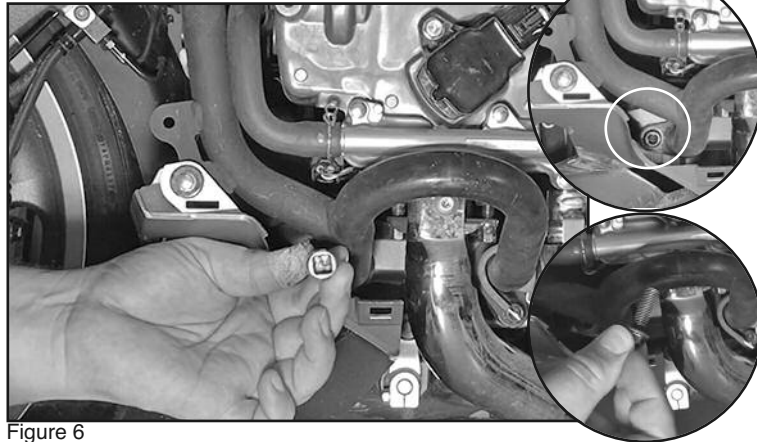

Figure 6

6. Remove the stock Screw holding the stock engine bar to the frame. This screw will not be re-used. **(12mm Socket, with Ratchet and Long Extension or no Extension if removing from front horn area.) Figure 6**



To easily locate this bolt follow the engine bar tube to the frame.



Figure 7, Black Cover Removed



Figure 8, Black Cover Altered

Remove or Alter the Black Cover

To install the P Clamp (10), you have a choice to remove the Black Cover permanently from the motorcycle as shown in figure 7, or alter the cover and re-install it as shown in figure 8 **Figure 7 and 8**

If you choose to leave it off, proceed to Page 6.

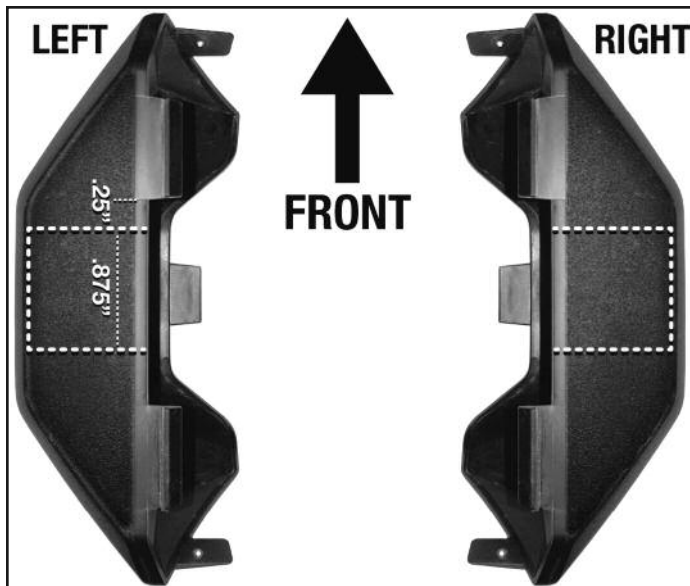



Diagram B



Figure 9



Figure 10

 To alter the Black Cover follow this easy procedure or visit www.nationalcycle.com for an installation video.

Altering Black Cover

1. Position the Covers as shown in **Diagram B**.

 Once the Covers are altered they are no longer symmetrical. The cut will start .25", (6mm) inside at the FRONT.
Cut is .875" (23mm) wide.

2. Use a pencil to mark the cut lines as shown in **Diagram B. (Pencil or Marker) Diagram B**

3. Use a Dremel with a 7/8" cutting tool or a Hack Saw with about 10 teeth per inch and a Blade to trim. **(Dremel with Cutting Tool or Saw and Blade) Figure 9**

 Helpful Hints: Hold the cover securely, by hand or in a vise. Wear safety glasses and protective gloves.

4. Repeat process on Right Cover.

5. Re-install the Black Cover onto the Valve Cover using the pins removed in Figure 3. **Figure 10**

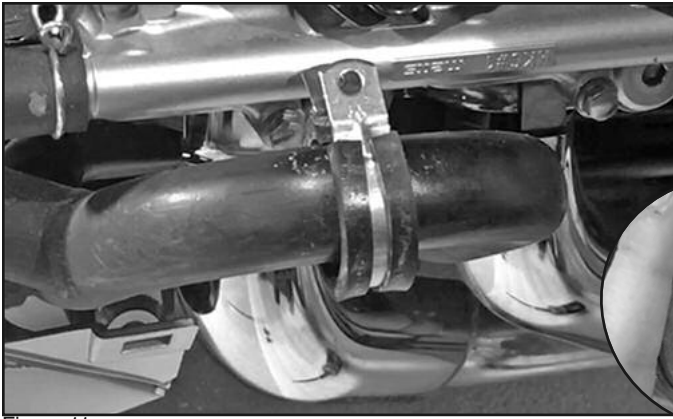

Figure 11

Flat Side to Outside

INSTALLATION

1. Install the "P" Clamp onto the stock engine bar. Flat Side Toward the Outside. **Figure 11**
2. Use the stock screws to Re-install the Valve Cover to motorcycle. **Figure 12**



Top of "P" Clamp extends out the top of the modified Black Cover. **Figure 12**

Install the Left Comfort Bar at Lower Mount Point.

3. Swing the lower section of the Bar through the open section of the lower plastic. **Figure 13**
4. Access the mount point from the front where horn was removed. Loosely secure in place using one Screw, M8 x 40 (3), Split Washer (4), and Washer (12). (**13mm Socket, with Ratchet**) **Figure 14**



Figure 12



Figure 13

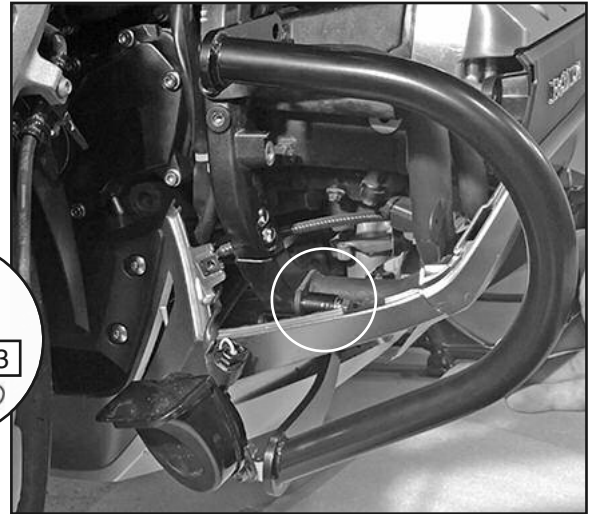
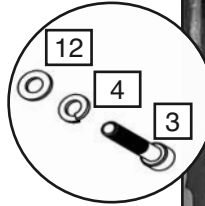
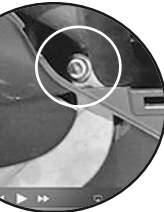

Figure 14

Install the Left Comfort Bar at Upper Mount Point.

5. Refer to Diagram C. Starting with the Rearward Screw (7), make an assembly using Washer (12) and Protective Sleeve (8). **Diagram C**

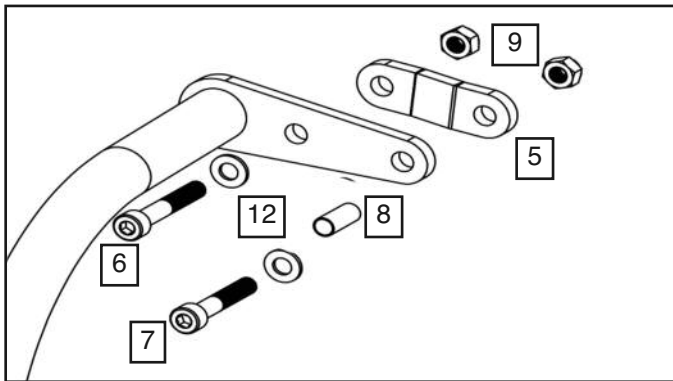

Diagram C

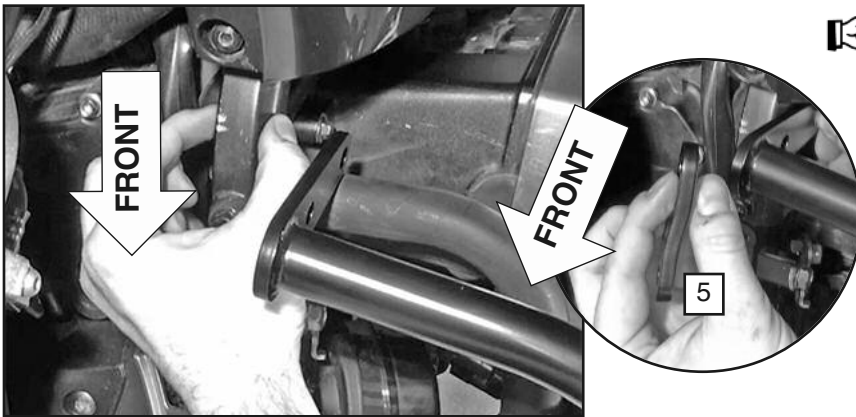



Figure 15

 The frame of the motorcycle is thicker at the front. For this reason the Backing Plate (5) has an offset. Position the offset to front and inside of the motorcycle as shown in the detail of **Figure 15**.

6. Install the Backing Plate at the Rear Mount Point using the fasteners as shown in **Diagram C**. Leave Loose. Do not fully tighten at this time. **(6mm Hex Wrench and 13mm Box Wrench) Diagram C, Figure 15 and 16**



Figure 16

7. Repeat procedure using fasteners for the Front Mount Point. Leave Loose. Do not fully tighten at this time. **(6mm Hex Wrench and 13mm Box Wrench) Diagram C, Figure 16**

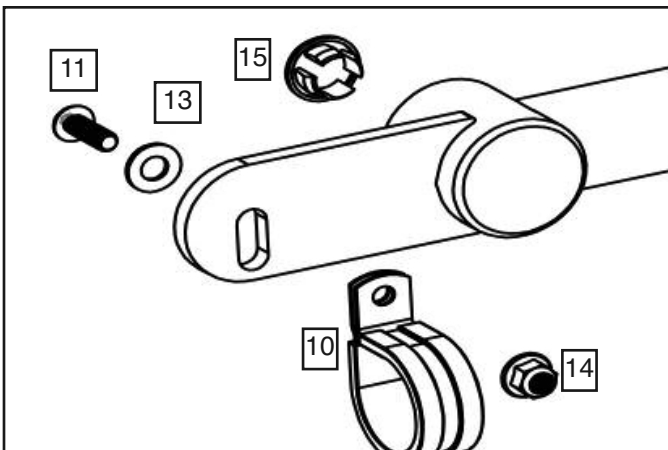



Diagram D

INSTALLATION

Install the "P" Clamp hardware

 Tape the Cover above the "P" clamp to protect from scratches. **(Tape) Figure 15**

1. Refer to Diagram D. Make an assembly using Screw (11) and Washer (13). Secure the "P" Clamp (10) to the Middle Mount Point of the Comfort Bar using Nut (14). **(3mm Hex Wrench and 8mm Box Wrench) Diagram D and Figure 17**



 Use a Needle Nose Pliers or light weight zip tie to assist in holding clamp shut while engaging hardware. **(Needle Nose Pliers) Figure 17**



Figure 17

INSTALLATION
Fully Tighten All Hardware

1. Tighten the Lower Mount Point.
 (13mm Socket, with Ratchet)
2. Tighten the Upper Mount Point.
 (6mm Hex Wrench and 13mm Box Wrench)
3. Tighten the Center Mount Point.
(3mm Hex Wrench and 8mm Box Wrench)
4. If not using a footrest, plug hole with Plug
 (15).

 **Repeat Installation On Right Side**
 When installing the right side Comfort Bar there is no need to remove the horn.

Enjoy your New Comfort Bars



OPTIONAL FOOTPEG EXTENDERS

- Foot Peg Mount Brackets are available in two lengths and finishes to match the Comfort Bars. **Diagram E**
- Attach your favorite footrests with our adjustable mounts that allow upward, rearward or downward positioning. **Figure 16**
- Fasteners to install the Footpeg Mount Kits are included in the Bags.
- Or install your favorite accessory (lights, horns, etc.) at any location on the bars
- Comfort Bars are constructed from 1.00" (25mm) tubing in your choice of – steel with e-coat and black powdercoat finish; or stainless steel with electropolished finish.

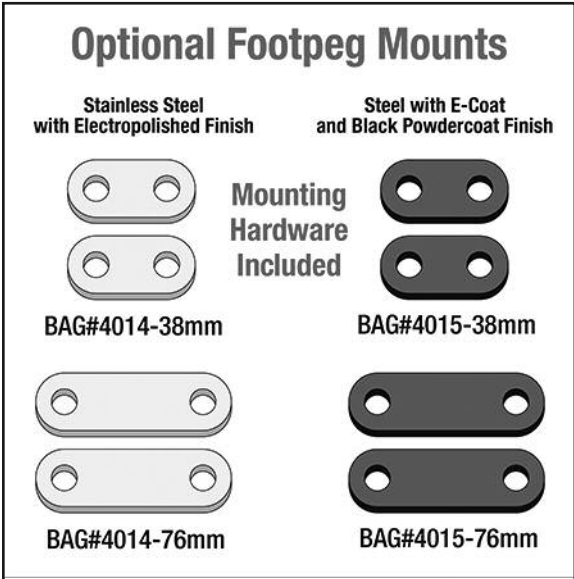

Diagram E