

Copyright © 2019 by Big Bike Parts, Inc. No part of this instruction sheet may be reproduced without the written permission of Big Bike Parts, Inc.

PART NO. 21-355L

TEARDROP PEG HIGHWAY MOUNT

FITMENT: HONDA GOLDWING/GOLDWING TOUR 2018-NEWER

3/19/2019

TOOLS NEEDED:	6MM ALLEN WRENCH	5MM ALLEN WRENCH	4MM ALLEN WRENCH	3MM ALLEN WRENCH	2MM ALLEN WRENCH
	7/16" WRENCH	8MM ALLEN WRENCH	1/4" ALLEN WRENCH	REMOVABLE THREAD LOCK	

PLEASE READ THROUGH AND UNDERSTAND THESE INSTRUCTIONS BEFORE BEGINNING. *USE REMOVABLE THREAD LOCK ON ALL FASTENERS*
ESTIMATED INSTALLATION TIME: 45 TO 60 MIN.

INSTALLATION:

- STARTING ON THE LEFT SIDE OF THE BIKE, REMOVE THE TWO SCREWS IN FIG. 1. PULL FORWARD ON THE LEFT FOG LIGHT COVER TO REMOVE IT.
- USE A 5MM ALLEN WRENCH TO REMOVE THE TWO ALLEN SCREWS IN THE LEFT LOWER COWL (FIG. 2).
- PULL BACK SLIGHTLY ON THE REAR OF THE LEFT LOWER COWL TO RELEASE IT.
- USING FIG. 3 AND FIG. 5 FOR REFERENCE, CAREFULLY RELEASE THE LEFT LOWER COWL TAB FROM THE LOWER SHROUD.
- RELEASE THE RUBBER GROMMET IN THE CENTER OF THE LEFT LOWER COWL (FIG. 4).
- SLIGHTLY PULL OUT ON THE BACK AND BOTTOM OF THE LEFT LOWER COWL AND SLIDE IT FORWARD AND OUT TO RELEASE THE TAB HOLDING THE FRONT OF THE LOWER COWL. REMOVE THE LEFT LOWER COWL AND PLACE IT ON A CLEAN TOWEL OR SOFT SURFACE TO AVOID SCRATCHING.
- REMOVE THE TWO CLIPS FROM THE ENGINE GUARD COVER (FIG. 5 SHOWS INSIDE OF THE LEFT LOWER COWL) CLIPS WILL NOT BE REUSED.
- PRESS THE THREE TABS INSIDE THE LOWER COWL TO RELEASE THEM AND REMOVE THE ENGINE GUARD COVER. COVER WILL NOT BE REUSED.
- PLACE ONE OF THE CLAMP TOPS ON THE ENGINE GUARD AS SHOWN IN FIG. 6.
- REPEAT STEPS 1 THROUGH 6 IN REVERSE ORDER.
- REFERENCE FIG. 6 TO INSTALL THE CLAMP BOTTOM AND THE LEFT HIGHWAY PEG. (DO NOT TIGHTEN. CLAMP CAN MOVE FORWARD OR BACK SLIGHTLY TO ADJUST POSITION/ANGLE OF THE BOARD.) ONCE IT IS IN THE DESIRED POSITION, TIGHTEN ALL BOLTS, AND THE SET SCREW LAST.
- REPEAT ON THE RIGHT SIDE OF THE BIKE.

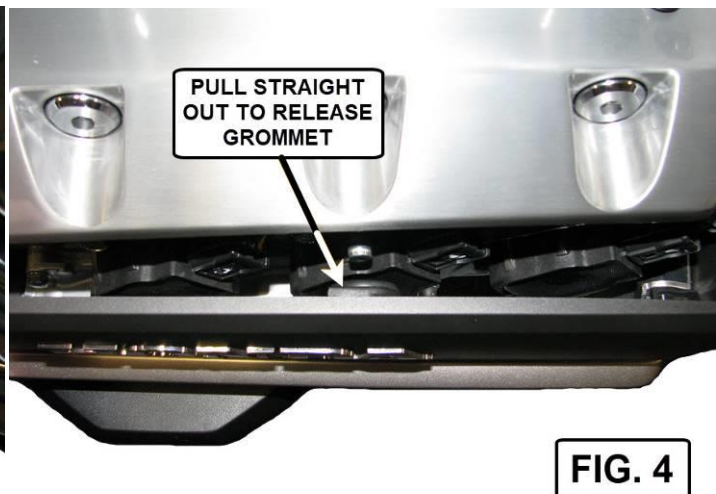
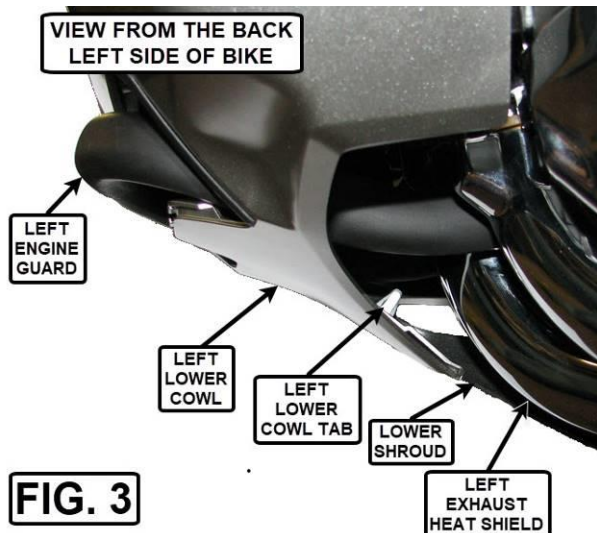
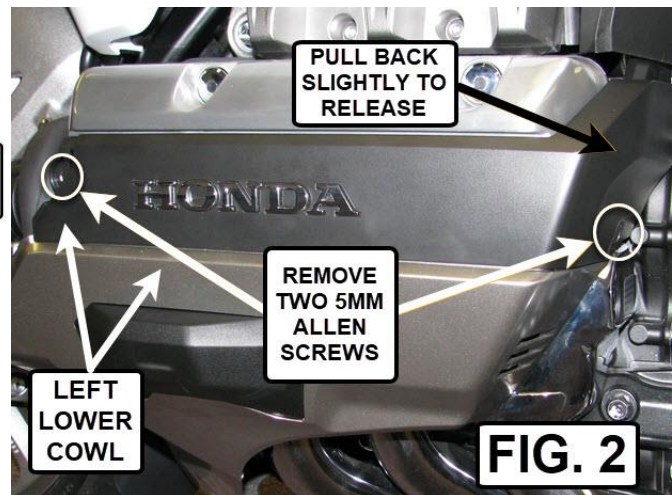
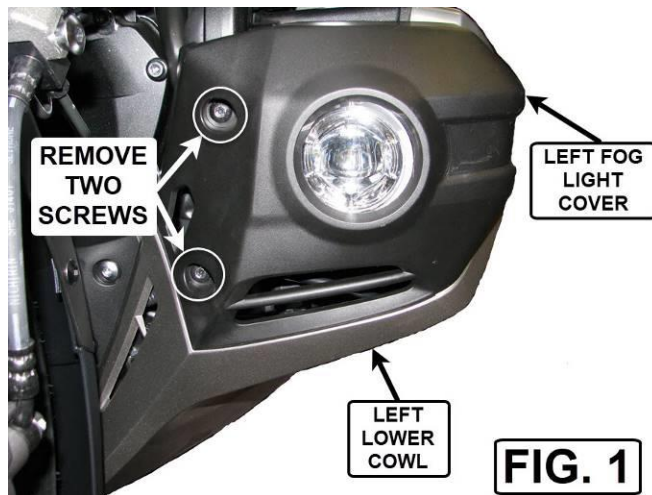

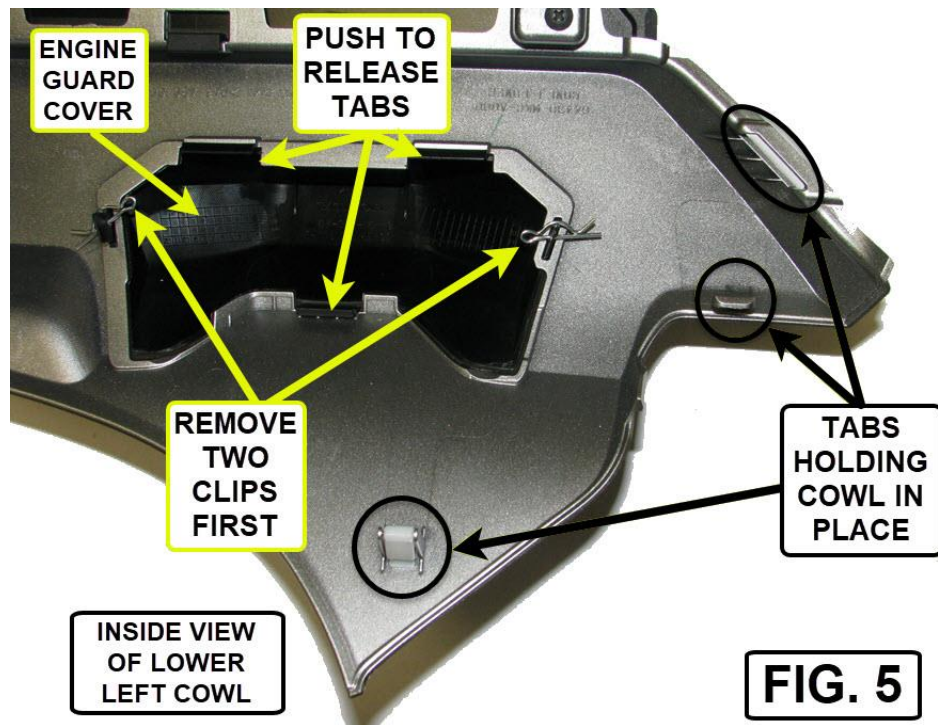

FIG. 5

NOTICE
 THIS SET CONTAINS EXTRA
 HARDWARE ITEMS THAT WILL
 NOT BE USED FOR THIS
 INSTALLATION

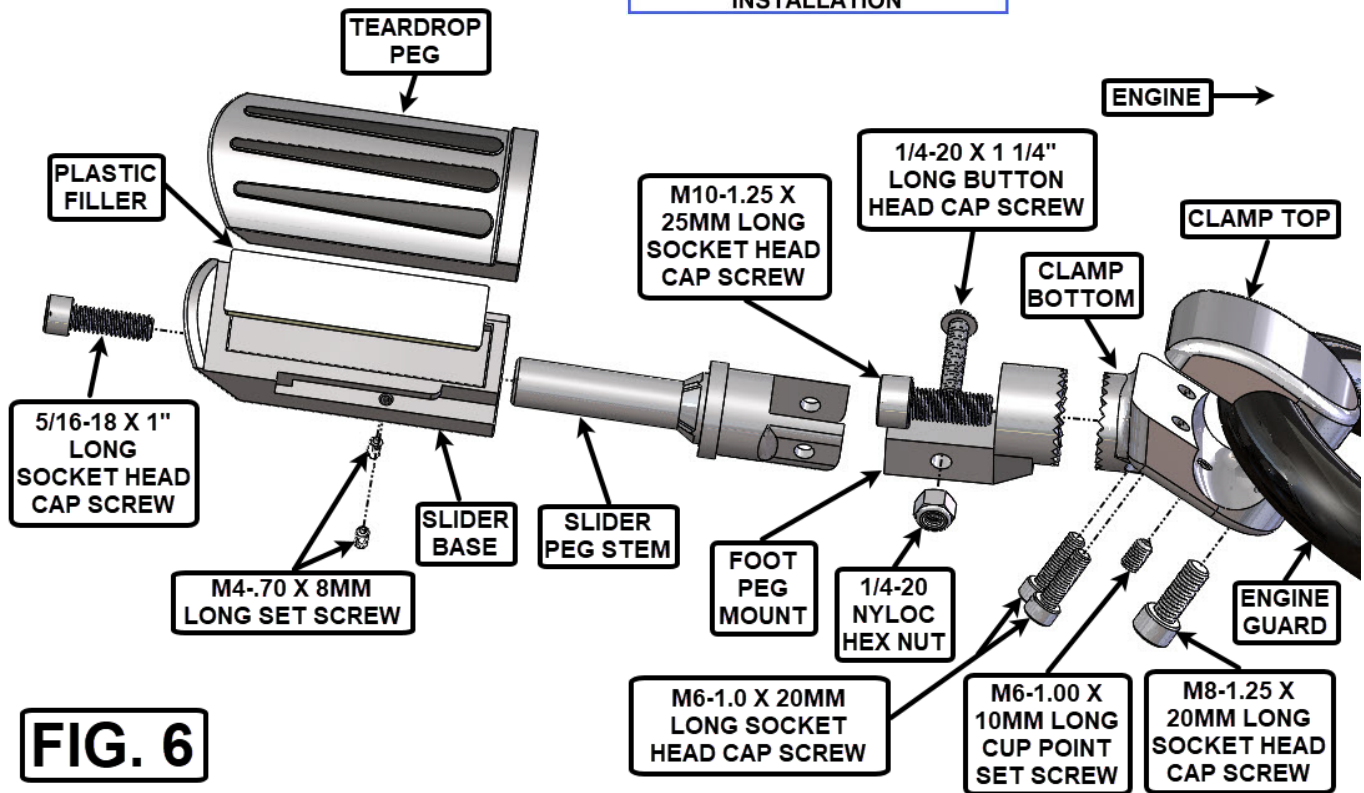

FIG. 6